

1300103001
 1300103003
 1346103005

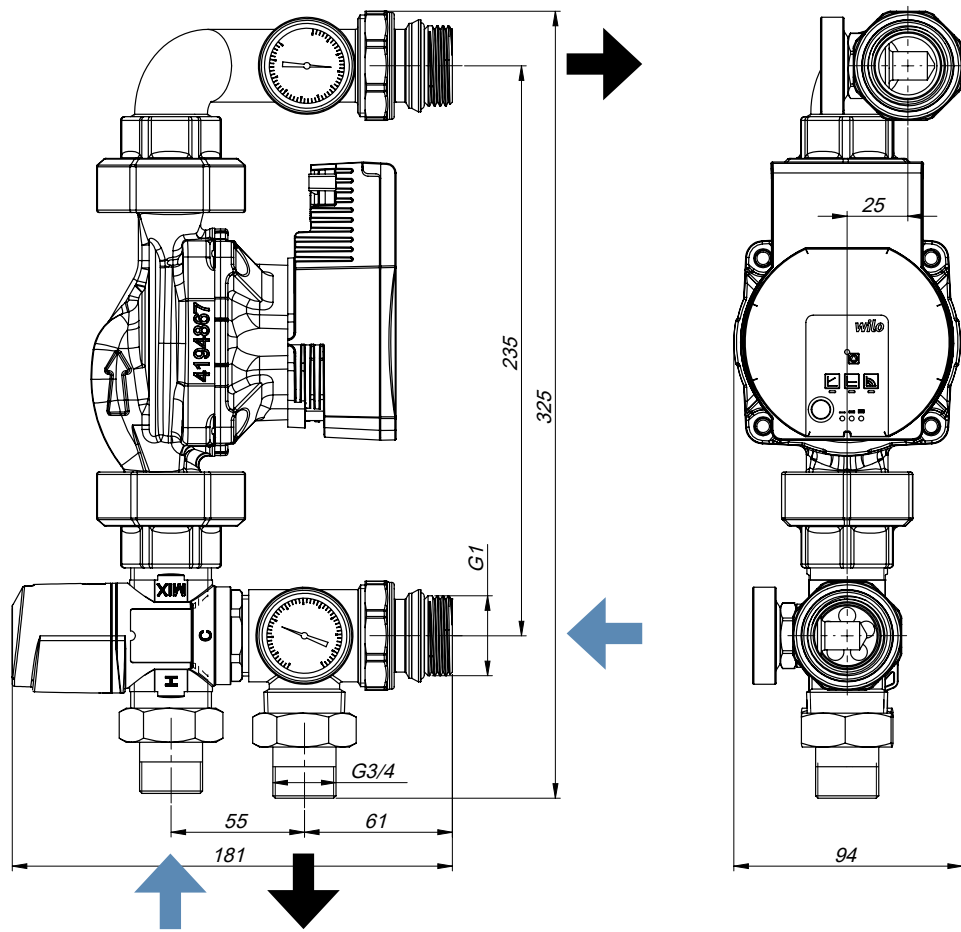

ATM 361 Kvs 1,6 (20 – 43 °C)
ATM 561 Kvs 2,5 (20 – 43 °C)
ATM 363 Kvs 1,6 (35 – 60 °C)

Set	ATM 361 ATM 561	ATM 363
1	20 °C	35 °C
2	25 °C	44 °C
3	30 °C	48 °C
4	34 °C	51 °C
5	38 °C	57 °C
6	43 °C	60 °C

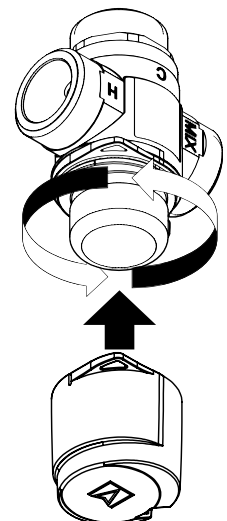
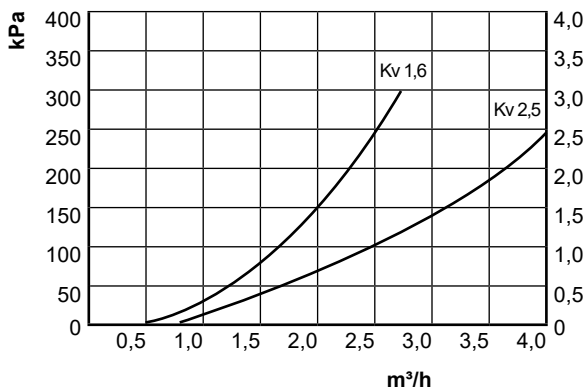

INST-GRUP_P1-2020-V2.2

T_{max}	90 °C
P_{max}	10 bar
H_2O	100%
Glycol	max 50%

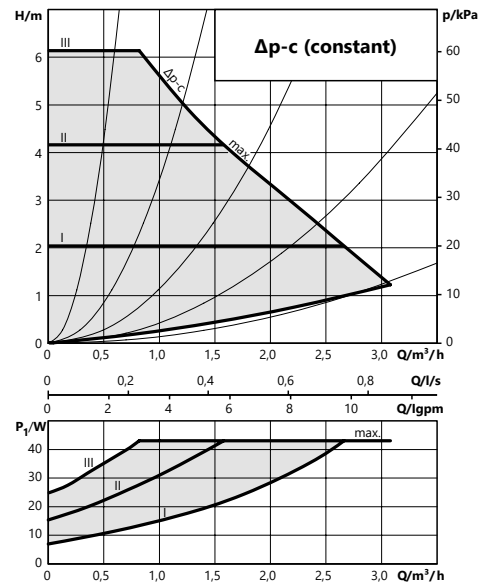
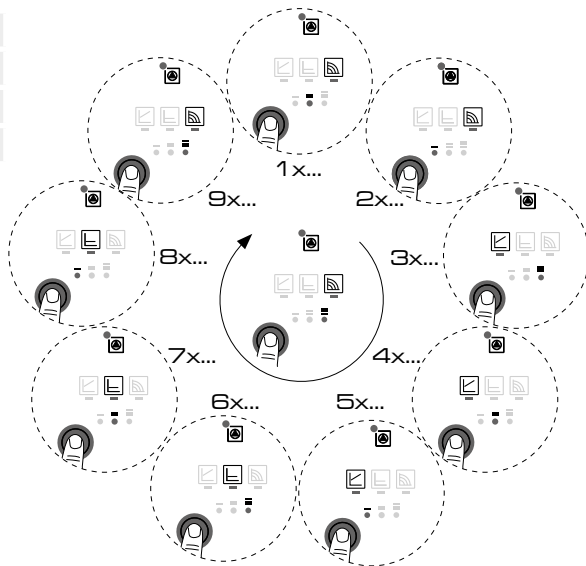

Stala różnica ciśnienia
Constant differential pressure Δp-c
Постоянный перепад давления Δp-c

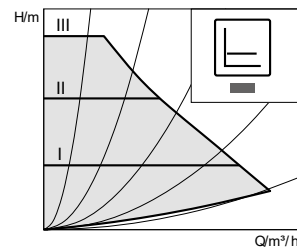

👍 Ustawienie zalecane
 Установка рекомендуется
 Recommended setting



Proporcjonalna różnica ciśnienia Δp-v
Differential pressure variable Δp-v
Пропорциональный перепад давления Δp-v

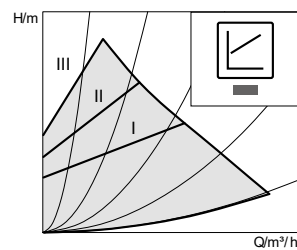

👎 Ustawienie niezalecane
 Setting not recommended
 установка не рекомендуется



Stala prędkość
Constant speed
Постоянная скорость

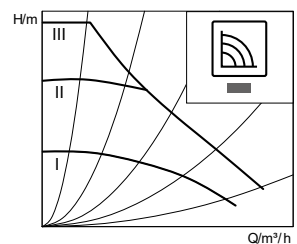

👎 Ustawienie niezalecane
 Setting not recommended
 установка не рекомендуется

INST-GRUP_P1-2020-V2.2