

# 1300103004

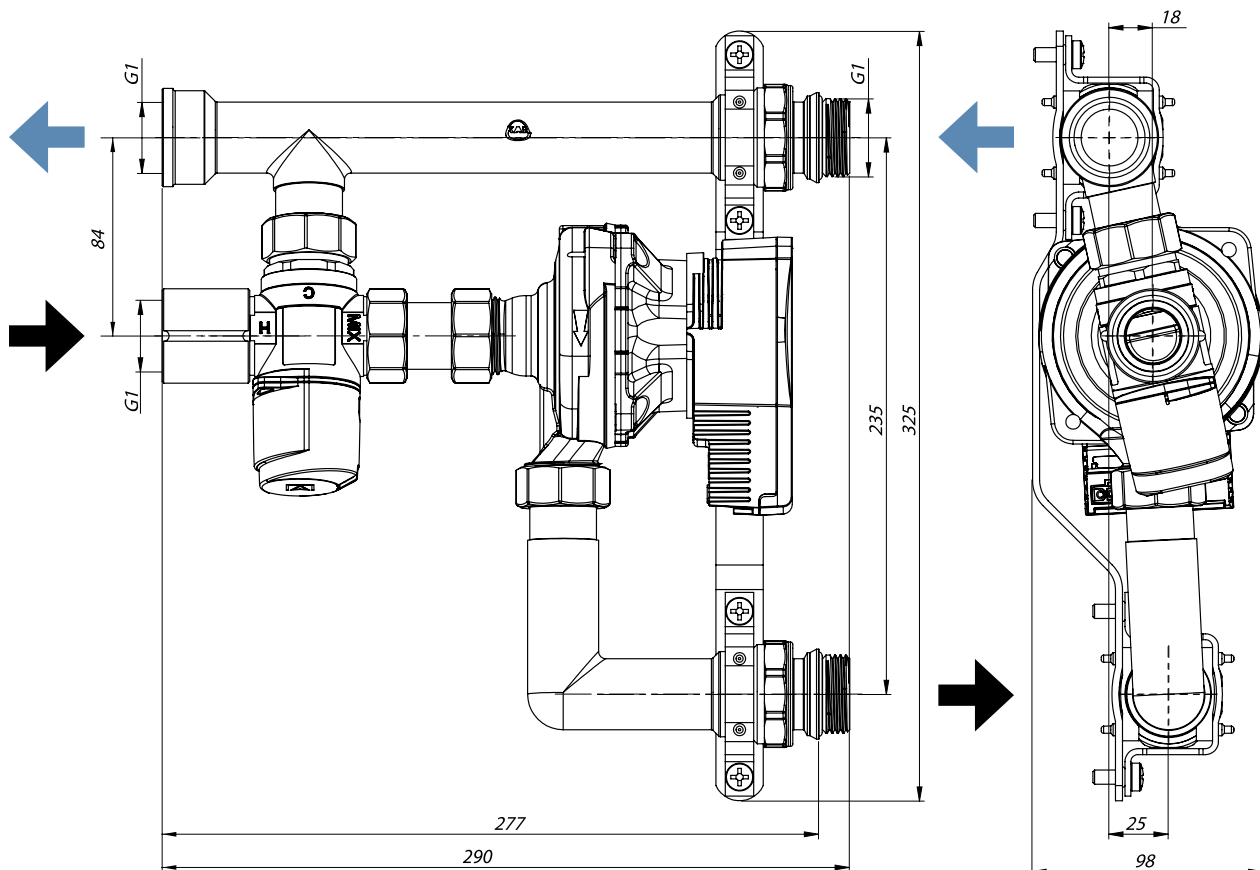

## 1. ATM 361 (20 – 43 °C)

Set	ATM 361
1	20 °C
2	25 °C
3	30 °C
4	34 °C
5	38 °C
6	43 °C

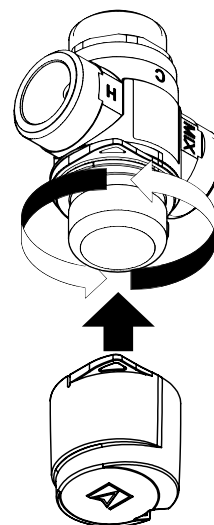
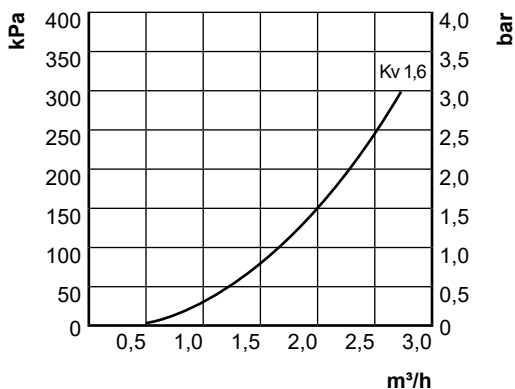

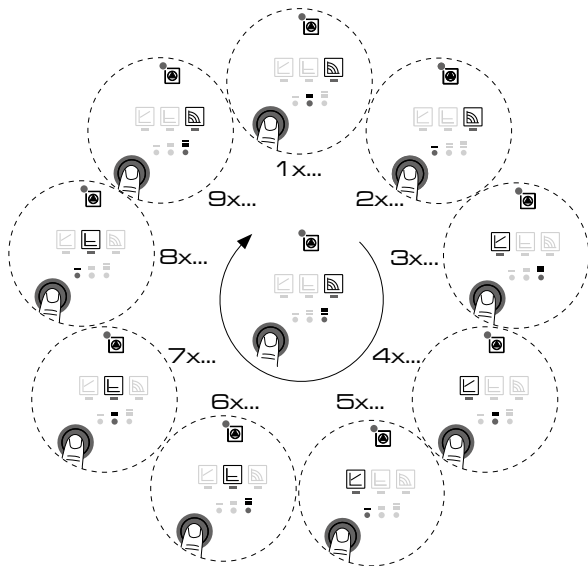

$T_{max}$	=	90 °C
$P_{max}$	=	10 bar
H <sub>2</sub> O		100%
Glycol		max 50%



**Stala różnica ciśnienia**  
**Constant differential pressure  $\Delta p-c$**   
**Постоянный перепад давления  $\Delta p-c$**

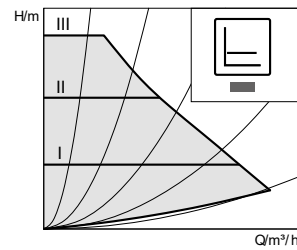

Ustawienie zalecane  
 Установка рекомендуется  
 Recommended setting



**Proporcjonalna różnica ciśnienia  $\Delta p-v$**   
**Differential pressure variable  $\Delta p-v$**   
**Пропорциональный перепад давления  $\Delta p-v$**

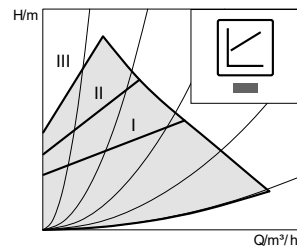

Ustawienie niezalecane  
 Setting not recommended  
 установка не рекомендуется



**Stala prędkość**  
**Constant speed**  
**Постоянная скорость**

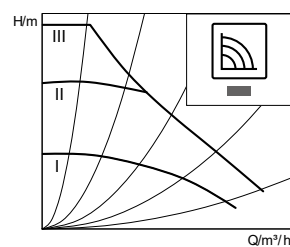

Ustawienie niezalecane  
 Setting not recommended  
 установка не рекомендуется