

1300103004

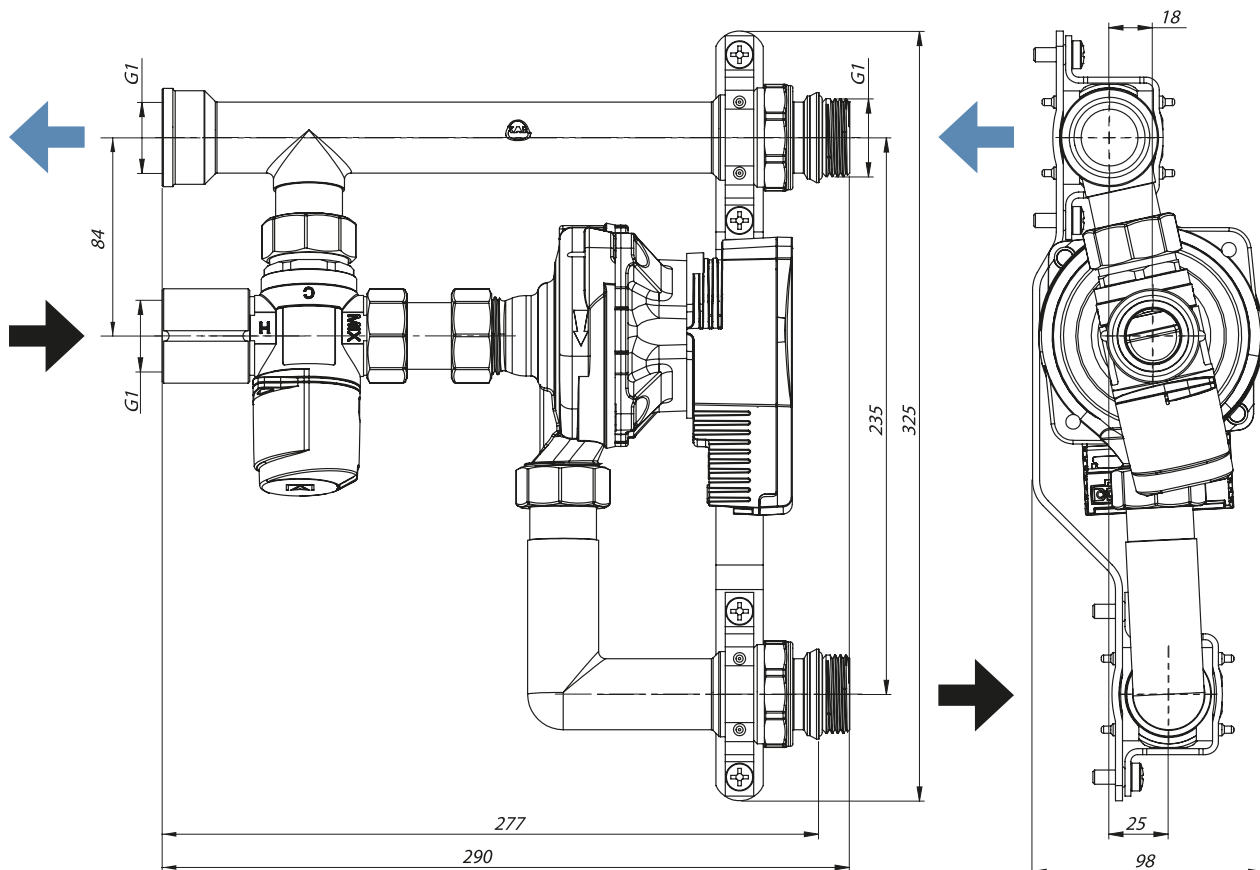

1. ATM 361 (20 – 43 °C)

Set	ATM 361
1	20 °C
2	25 °C
3	30 °C
4	34 °C
5	38 °C
6	43 °C

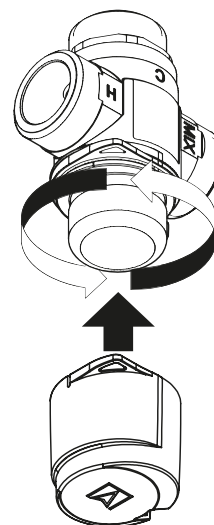
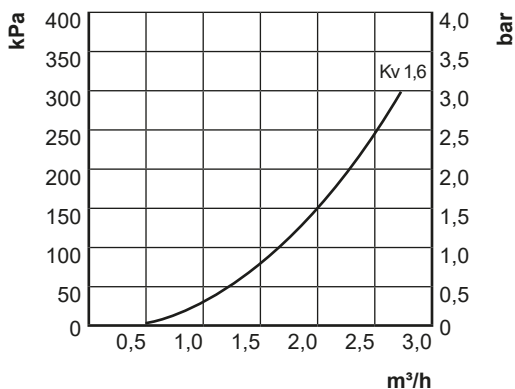

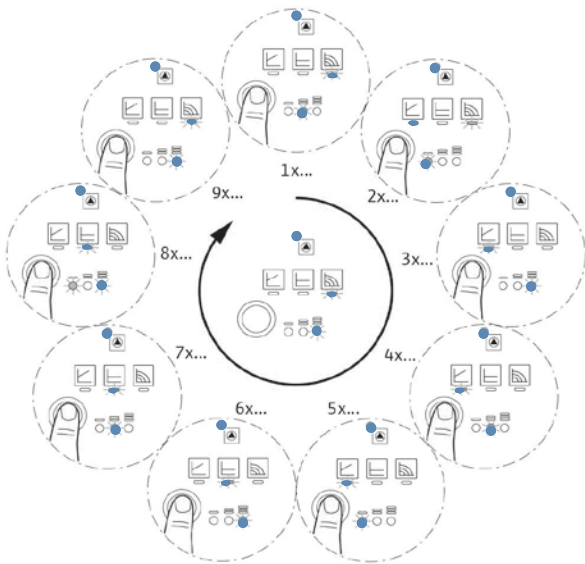

T _{max} =	90 °C
P _{max} =	10 bar
H ₂ O	100%
Glycol	max 50%

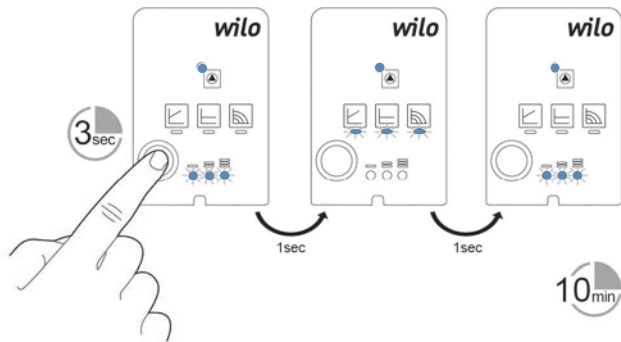

Differenzdruck konstant Constant differential pressure $\Delta p-c$

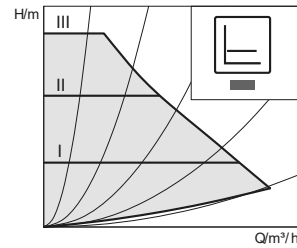

👍 Empfohlene
Einstellung
Recommended
setting

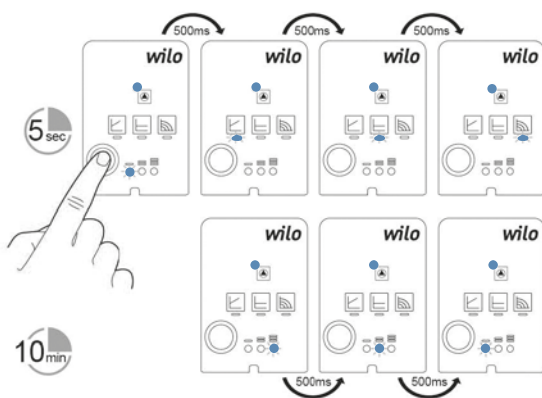

Differenzdruck variabel $\Delta p-v$ Differential pressure variable $\Delta p-v$

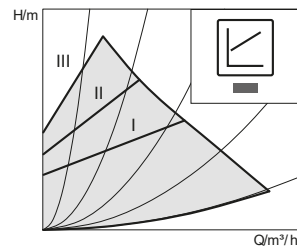

👎 Einstellung nicht
empfohlen
Setting not
recommended

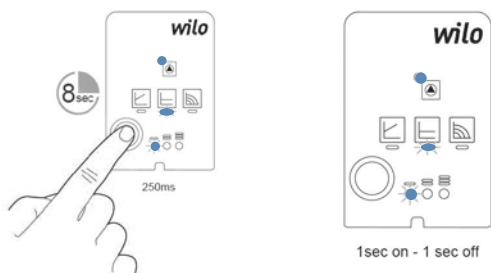

Konstant-Drehzahl Constant speed

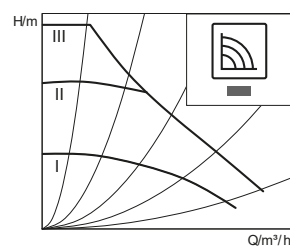

👎 Einstellung nicht
empfohlen
Setting not
recommended